

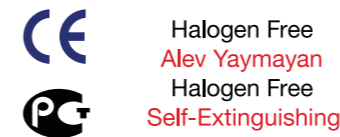



Akım	Current	24A
Gerilim	Voltage	450V
İletken Tipi	Conductor Type	Tek Damarlı Rigid
İletken Kesiti	Conductor Cross-Section	1,0 - 2,5 mm ²
Min. Çalışma Sıcaklığı	Min. Working Temp.	-30°C
Max. Çalışma Sıcaklığı	Max. Working Temp.	+110°C
Gövde	Housing	(PC)

Buat İçi Yaylı Klemens
Push-in Type Connector



Uygulama Yerleri

Anahtar Kasaları
Dağıtım Kutuları
Elektrik Panoları
Aydınlatma Armatürleri
Güvenlik /Alarm Sistemleri
Prefabrik Kablolama Sistemleri

Applications

Junction Boxes
Distribution Boxes
Control Panels
OEM Lighting Manufacturing
Security/Alarm Systems
Prefabricated Wiring Systems

Sipariş Kodu Order Code	Renk Color	Giriş Sayısı Ports	Ambalaj Packing
PC2252	Kırmızı Red	2	500
PC2253	Turuncu Orange	3	500
PC2254	Sarı Yellow	4	500
PC2255	Gri Grey	5	500
PC2258	Siyah Black	8	250

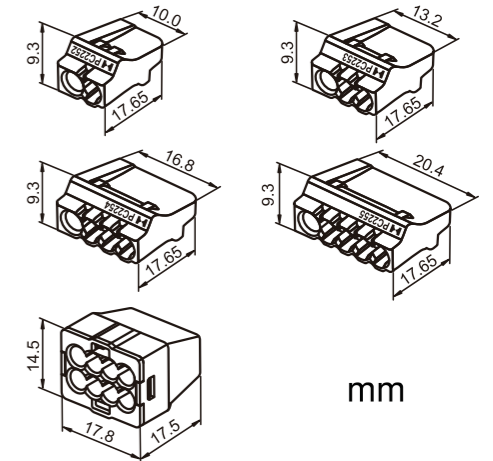

Kullanım Şekli Installation



- 1.ELEKTRİĞİ KESİNİZ.**
Tek damarlı kabloyu yaklaşık 11 mm soyun. Soyma boyu klemensin üzerindedir.
 - 2.Soyulmuş iletkeni bastırarak deliğe sokun.** Çevirmeye veya bantlamaya gerek kalmamıştır.
 - 3.Bağlantıyı test etmek için klemensin üzerindeki yarığı kullanınız.**
- Buat içi bağlantınız hazır.
- 1.TURN OFF POWER.**
Strip wire approx. 11 mm. The stripping length is built on the connector.
 - 2.Push stripped solid conductor into the port of connector fully,** no more twisting or taping required.
 - 3.Use a voltage tester to test your connection via the slot on the connector.**
- Your connection is ready.

Uyarı: Bağlantıyı düzeltmek veya değiştirmek için, çıkaracağınız kabloyu tutup; yavaşça sağa ve sola doğru çevirerek ve çekerek çıkarınız.

Note: To correct or change wires, hold the wire to be removed firmly, then twist alternately left and right while pulling on the connector.

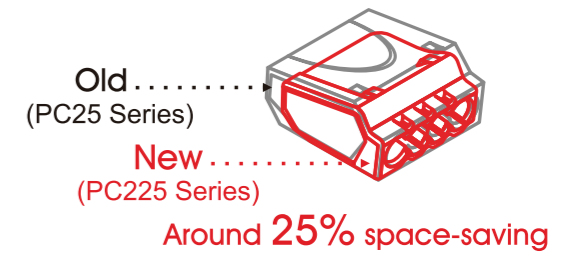

Aydınlatma Klemensleri Lighting Connectors

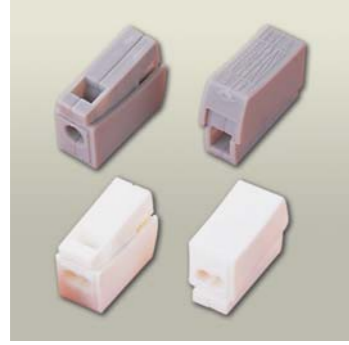

İletken Tipi: Tek ve Çok Damarlı
Min. Çalışma Sıcaklığı: -30 °C
Max. Çalışma Sıcaklığı: +110°C
Gövde: Poliamid (PA)

Conductor Type: Rigid and Stranded
Min. operating temp.: -30 °C
Max. operating temp.: +110 °C
Housing: Polyamide (PA)

Halogen Free
Alev Yayımayan
Halogen Free
Self-Extinguishing



Sipariş Kodu Order Code	İletken Kesti Conductor Cross Section	Gerilim Voltage	Akım Current	Ambalaj Packing
YKPC301	0,75 - 2,5 mm ²	450V	24A	500
YKPC302	0,75 - 2,5 mm ²	450V	24A	500

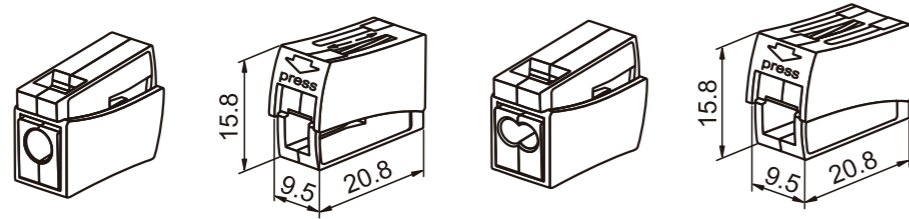

YKPC301

YKPC302

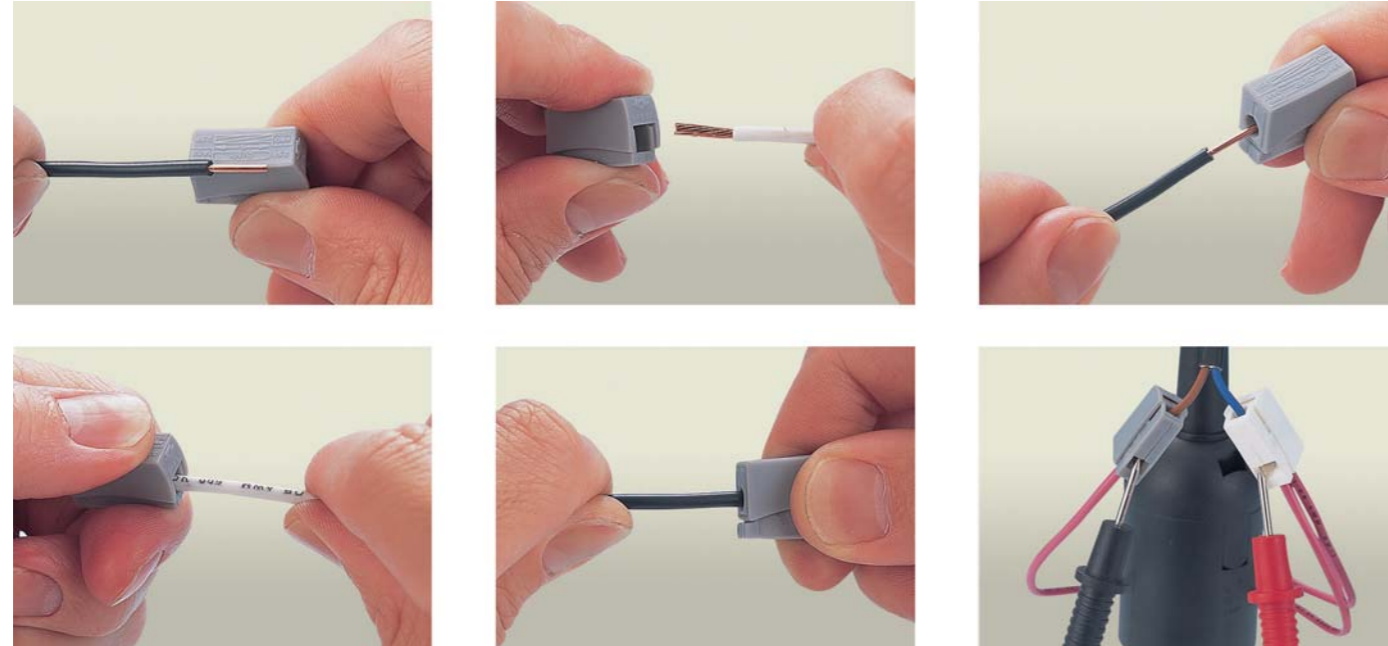

Klemensler Connectors



İletken Tipi: Tek ve Çok Damarlı
Min. Çalışma Sıcaklığı: -30 °C
Max. Çalışma Sıcaklığı: +110°C
Gövde: PC ve PA

Conductor Type: Rigid and Stranded
Min. operating temp.: -30 °C
Max. operating temp.: +110 °C
Housing: Polyamide PC and PA

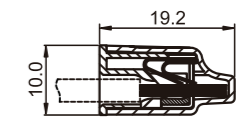
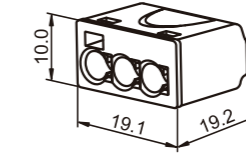

Buat İçi Yaylı Klemens
1,0 - 4,0 mm²
Push-in Type
Connectors 1,0 - 4,0
mm²

Halogen Free
Alev Yayımayan
Halogen Free
Self-Extinguishing



Sipariş Kodu Order Code	İletken Kesti Conductor Cross Section	Gerilim Voltage	Akım Current	Ambalaj Packing
YKPC883	1,0 - 4,0 mm ²	450V	32A	500

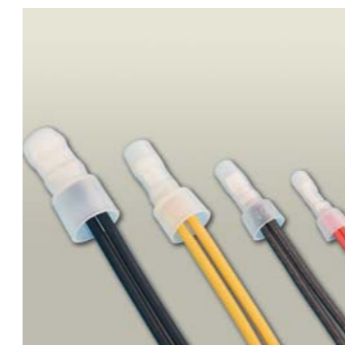
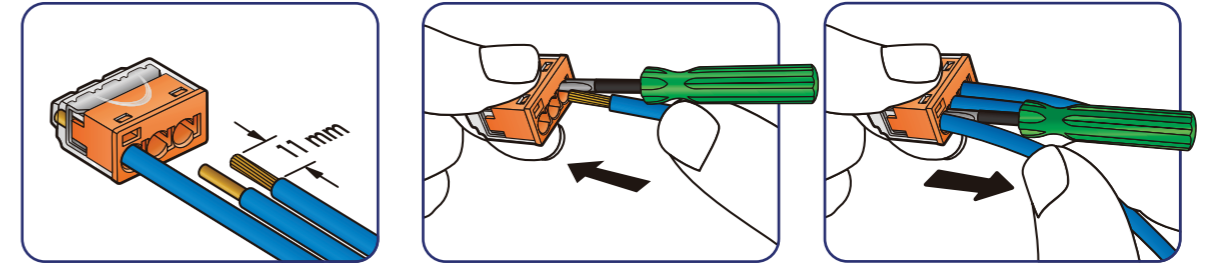

İletken Tipi: Tek ve Çok Damarlı
Min. Çalışma Sıcaklığı: -30 °C
Max. Çalışma Sıcaklığı: +105°C
Gövde: Poliamid (PA)

Conductor Type: Rigid and Stranded
Min. operating temp.: -30 °C
Max. operating temp.: +105 °C
Housing: Polyamide (PA)

Sipariş Kodu Order Code	İletken Kesti Conductor Cross Section	Gerilim Voltage	Ambalaj Packing
YKPCCE1	0,65 - 2,62 mm ²	300V	1000
YKPCCE2	0,65 - 3,93 mm ²	300V	1000
YKPCCE5	0,64 - 9,14 mm ²	300V	1000
YKPCCE8	4,16 - 17,14 mm ²	300V	500

Yüksüklü Buat
Klemensleri

Close-End Wire
Connectors

Halogen Free
Alev Yayımayan
Halogen Free
Self-Extinguishing

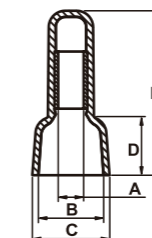

Sipariş Kodu Order Code	A	B	C	D	E
YKPCCE1	2,6	6,2	7,8	6,0	18,0
YKPCCE2	3,1	7,9	9,5	7,0	20,0
YKPCCE5	4,4	10,5	12,5	9,6	25,5
YKPCCE8	5,3	12,4	14,3	12,0	27,7



Şeffaf Esnek
Sıra Klemensler
Transparent Flexible
Terminal Blocks

Halogen Free
Alev Yayan
Halogen Free
Non Self-Extinguishing



Terminal: Nikel Kaplı Pirinç
Vida: Çinko Kaplı Çelik
Min. Çalışma Sıcaklığı: -15°C
Max. Çalışma Sıcaklığı: +75°C
Gövde: Polietilen (PE)

Terminal: Nickel Plated Brass
Screw: Zinc Plated Steel
Min. Operating Temp.: -15°C
Max. Operating Temp.: +75°C
Housing: Polyethylene (PE)

Sipariş Kodu Order Code	No	Kesit Cross Section	Akım/Gerilim Current/Voltage	Vida Screw	Ambalaj Packing
YKPA8PE	0	2.5 mm ²	6A / 400V	M2.6x5	50
YKPA10PE	1	4 mm ²	10A / 400V	M3.0x6	50
YKPA12PE	2	6 mm ²	16A / 400V	M3.5x7	40
YKPA14PE	3	10 mm ²	32A / 400V	M4.0x9	25
YKPA16PE	4	16 mm ²	40A / 400V	M4.0x9	10
YKPA18PE	5	25 mm ²	60A / 400V	M5.0x11	10



Esnek
Sıra Klemensler
Flexible
Terminal Blocks

Alev Yayımayan
Non Self-Extinguishing



Terminal: Nikel Kaplı Pirinç
Vida: Çinko Kaplı Çelik
Min. Çalışma Sıcaklığı: -15°C
Max. Çalışma Sıcaklığı: +85°C
Gövde: Polipropilen (PP)

Terminal: Nickel Plated Brass
Screw: Zinc Plated Steel
Min. Operating Temp.: -15°C
Max. Operating Temp.: +85°C
Housing: Polypropylene (PP)

Sipariş Kodu Order Code	No	Kesit Cross Section	Akım/Gerilim Current/Voltage	Vida Screw	Ambalaj Packing
YKPA8P	0	1.5 mm ²	17.5A / 450V	M2.6x5	50
YKPA10P	1	2.5 mm ²	24A / 450V	M3.0x6	50
YKPA12P	2	6 mm ²	41A / 500V	M3.5x7	40
YKPA14P	3	10 mm ²	57A / 500V	M4.0x9	25
YKPA16P	4	16 mm ²	76A / 500V	M4.0x9	10
YKPA18P	5	25 mm ²	101A / 500V	M5.0x11	10

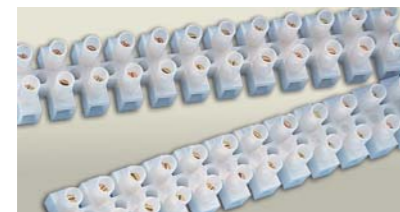

Sıra Klemensler
Terminal Blocks

Halogen Free
Alev Yayımayan
Halogen Free
Self-Extinguishing



Terminal: Nikel Kaplı Pirinç
Vida: Çinko Kaplı Çelik
Min. Çalışma Sıcaklığı: -15°C
Max. Çalışma Sıcaklığı: +110°C
Gövde: Poliamid (PA)

Terminal: Nickel Plated Brass
Screw: Zinc Plated Steel
Min. Operating Temp.: -15°C
Max. Operating Temp.: +110°C
Housing: Polyamide (PA)

Sipariş Kodu Order Code	No	Kesit Cross Section	Akım/Gerilim Current/Voltage	Vida Screw	Ambalaj Packing
YKPA8	0	1.5 mm ²	17.5A / 450V	M2.6x5	50
YKPA10	1	2.5 mm ²	24A / 450V	M3.0x6	50
YKPA12	2	6 mm ²	41A / 500V	M3.5x7	40
YKPA14	3	10 mm ²	57A / 500V	M4.0x9	25
YKPA16	4	16 mm ²	76A / 500V	M4.0x9	10
YKPA18	5	25 mm ²	101A / 500V	M5.0x11	10



Yüksük Klemensler
Screw-On Wire
Connectors

Halogen Free
Alev Yayımayan
Halogen Free
Self-Extinguishing



Kare Kesitli Yay
Min. çalışma sıcaklığı: -15°
Max. çalışma sıcaklığı: +105°
Gövde: Poliamid (PA)

Square Wire Spring
Min. operating temp.: -15°
Max. operating temp.: +105°
Housing: Polyamide (PA)

Sipariş Kodu Order Code	Kesit Cross Section	Gerilim Voltage	Renk Color	Ambalaj Packing
YKP1	0.65 - 2.62 mm ²	300V	Gri Grey	1000
YKP2	0.65 - 3.93 mm ²	300V	Mavi Blue	1000
YKP3	1.34 - 5.76 mm ²	600V	Turuncu Orange	500
YKP4	0.64 - 9.14 mm ²	600V	Sarı Yellow	500
YKP6	4.16 - 17.14 mm ²	600V	Kırmızı Red	500



Kanatlı Yüksük Klemensler
Winged Wire
Connectors

Halogen Free
Alev Yayımayan
Halogen Free
Self-Extinguishing



Kare Kesitli Yay
Min. çalışma sıcaklığı: -15°
Max. çalışma sıcaklığı: +105°
Gövde: Poliamid (PA)

Square Wire Spring
Min. operating temp.: -15°
Max. operating temp.: +105°
Housing: Polyamide (PA)

Sipariş Kodu Order Code	Kesit Cross Section	Gerilim Voltage	Renk Color	Ambalaj Packing
YKP11	1.64 - 9.93 mm ²	600V	Sarı Yellow	500
YKP12	0.65 - 9.93 mm ²	600V	Bej Beige	500
YKP13	1.64 - 21.00 mm ²	600V	Kırmızı Red	500
YKP15	1.64 - 21.00 mm ²	600V	Gri Grey	250
YKP17	9.93 - 29.90 mm ²	600V	Mavi Blue	100



Topraklama Klemensi
Grounding Connector

Halogen Free
Alev Yayımayan
Halogen Free
Self-Extinguishing



Kare Kesitli Yay
Min. çalışma sıcaklığı: -15°
Max. çalışma sıcaklığı: +105°
Gövde: Poliamid (PA)

Square Wire Spring
Min. operating temp.: -15°
Max. operating temp.: +105°
Housing: Polyamide (PA)

Sipariş Kodu Order Code	Kesit Cross Section	Gerilim Voltage	Renk Color	Ambalaj Packing
YKP99	5.76 - 9.14 mm ²	-	Yeşil Green	500